

Coastal Industries Inc.

FAX NO.
(904) 641-1697

P.O BOX 16091
JACKSONVILLE FLORIDA 32246

TELEPHONE NO.
(904) 642-3970

Paragon By-Pass unit Installation Instructions

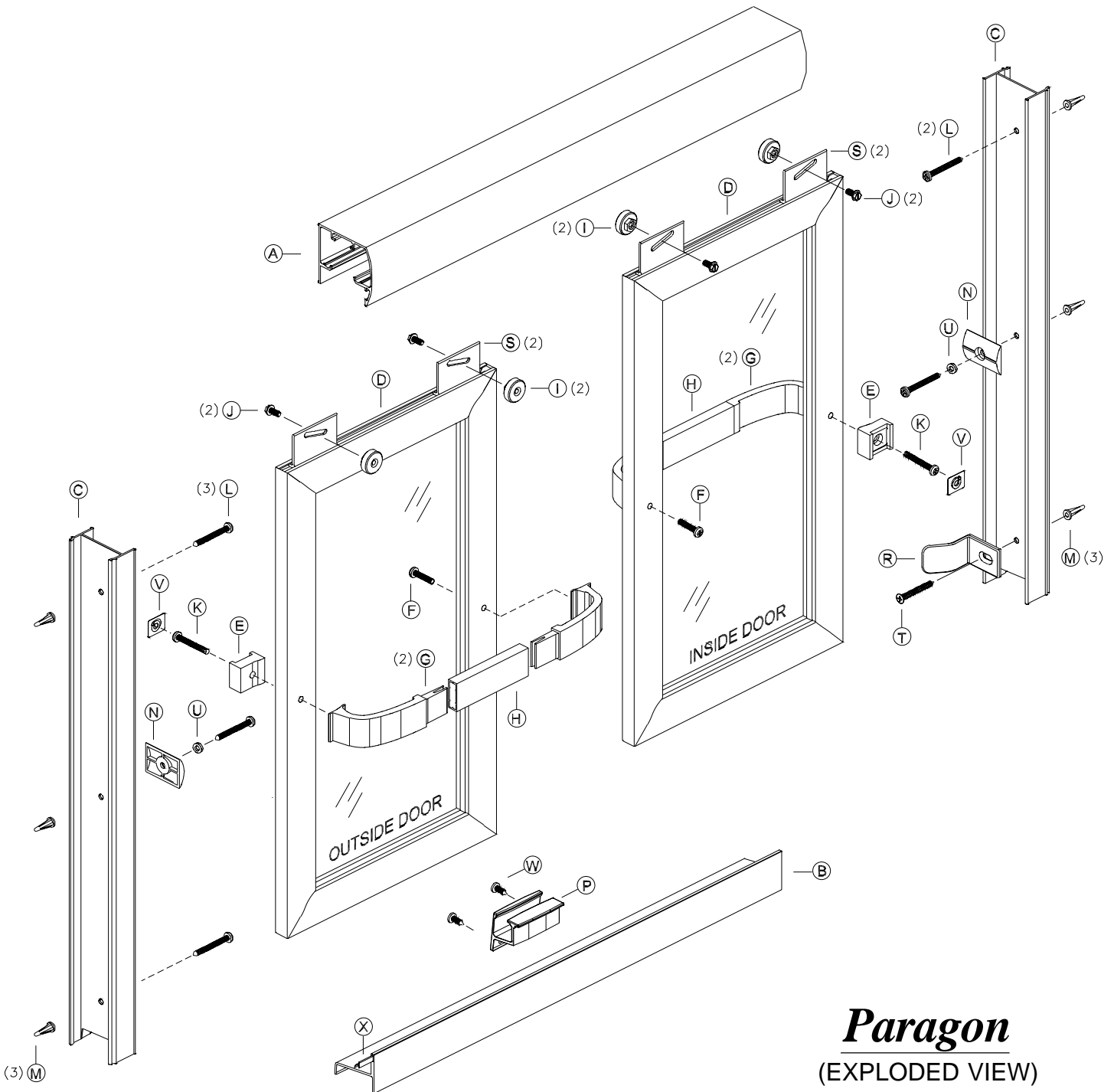

Paragon
(EXPLODED VIEW)

PARTS LIST

KEY LETTER	PART NUMBER	DESCRIPTION	QUANTITY
A	620	HEADER	1
B	651	SILL	1
C	643	WALL JAMB	2
D	---	DOOR PANEL ASSEMBLY	2
E	8156	FINGER PULL, TOWEL BAR	2
F	832MSPHP	TOWEL BAR W/ NO FINGER PULL SCREW	2
G	CP22	TOWEL BAR BRACKETS	4
H	21	TOWEL BAR	2
I	PN193	ROLLER (attached)	4
J	832HEX	ROLLER SCREWS (attached)	4
K	832114	TOWEL BAR W/ FINGER PULL SCREW	2
L	8112	INSTALLATION SCREWS	5
M	1329	PLASTIC SCREW ANCHOR	6
N	5169	BUMPER	2
P	CP1111	TRACK GUIDE	1
R	CP110	JAMB GUIDE	1
S	35	HANGER BRACKET (installed)	4
T	82F	JAMB GUIDE SCREW	1
U	CP104TW	BUMPER WASHER	2
V	8157	CI LOGO (STICKER)	2
W	638PHPT	#6x3/8" SELF DRILLING SCREW	2
X	C494B	SILL SEAL VINYL	1

TOOLS NEEDED

HACKSAW	STANDARD SCREW DRIVER OR 1/4'
ELECTRIC DRILL	LEVEL
3/16" MASONRY DRILL BIT	HAMMER
PENCIL / FELT TIP PEN	CENTER PUNCH
SAFETY GLASSES	PHILLIPS SCREW DRIVER
MEASURING TAPE	CLEAR CAULKING OR SEALANT (MII)
MASKING TAPE	

Unit Installation Screws (shown full size for reference)

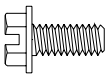

(J)_832HEX
ROLLER SCREW

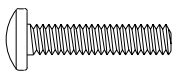

(F)_832MSPHP
TOWEL BAR SCREW

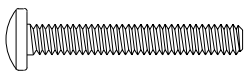

(K)_832114 TOWEL BAR
WITH FINGER PULL SCREW

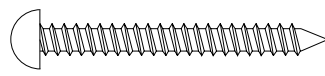

(L)_8112 INSTALLATION SCREW

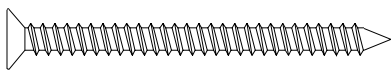

(T)_82F JAMB GUIDE SCREW

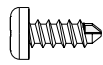

(W)_638PHT TRACK GUIDE SCREW

BEFORE STARTING

Please check the box contents against the parts list. *Make sure that all material is accounted for before starting unit installation.*

STEP 1 Measure base opening & cut Sill

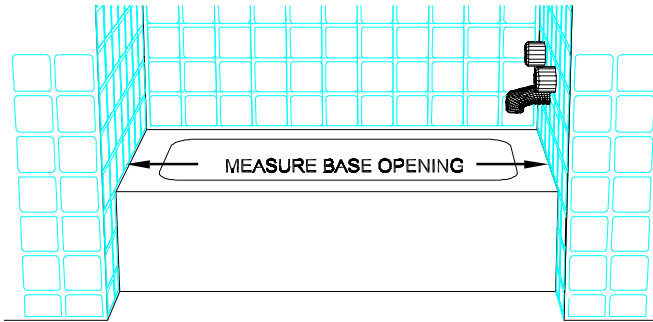

Measure the base opening along center of shower curb as shown in figure 1, then trim Sill (B) to measurement obtained.

STEP 2 Trim Insert Vinyl Seal into Sill

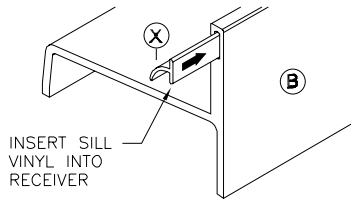

Trim the Vinyl Seal (X) to an inch and one eighth (1-1/8") less than the base opening. Slide Vinyl Seal into the Sill's receiver as shown in figure 2 and center it on the Sill.

STEP 3 Position Sill and Wall Jamb

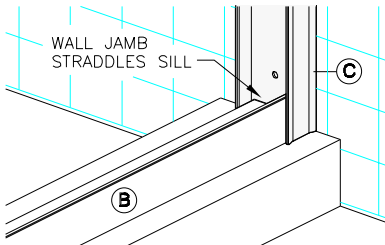

With high lip toward exterior of enclosure, position Sill at center of shower curb. Temporarily tape Sill to shower curb to prevent movement.

Place Wall Jamb (C) on to ends of Sill (B) and up against shower walls as shown in figure 3. Push the notched Wall Jamb down over the Sill, making sure the Jamb is securely seated onto the Sill. Plumb the Jamb, then pencil mark their installation hole locations on the shower walls (3 per jamb). Remove Wall Jamb. Using a 3/16" glass / tile drill bit, drill 1" deep installation holes in locations previously marked. Insert Plastic Screw Anchors (M) into holes.

STEP 4 Secure Wall Jamb

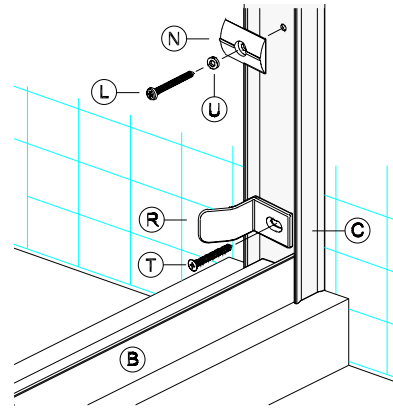

Reposition Wall Jamb as before and secure to shower walls using five (5) #8 x 1-1/2" Installation Screws (L), see exploded view - sheet 1.

Ensure that both Jamb Bumpers (N) and Bumper Washers (U) are secured to the Wall Jamb (C) using the center installation screw, see figure above and exploded view - sheet 1.

Use the #8 x 2" Flat Head Screw (T) to secure Jamb Guide (R) to the lower installation hole of the Wall Jamb that is attached to the shower head wall.

STEP 5 Measure Header opening & cut Header

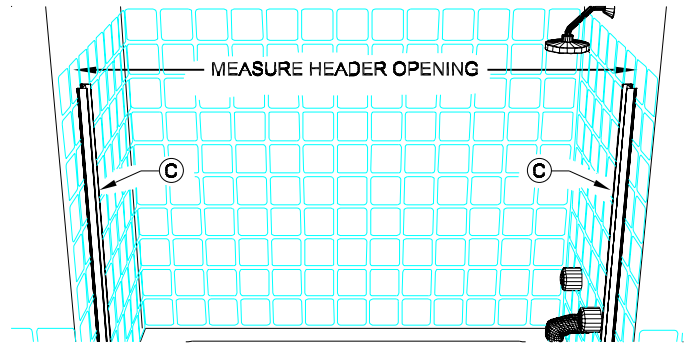

Measure the wall to wall opening at the top of the Wall Jamb (C) and cut the Header (A) to 1/16" less than the measurement obtained. Position Header (A) on top of the Wall Jamb (C) and leave it there as we make preparations for panel installation.

STEP 6 Door Panel Installation

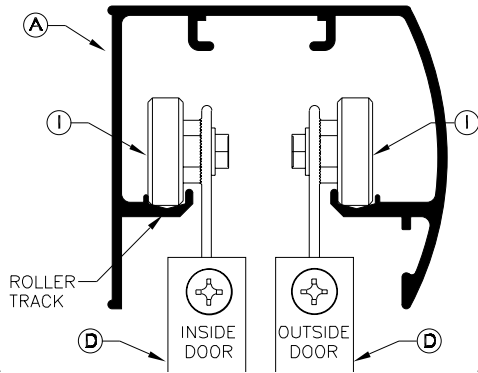

Take what will be the inside Panel and stand it inside the shower enclosure (make sure the Rollers are facing toward the inside of the enclosure as shown in exploded view - sheet 1). Leave it there temporarily.

Install the outside Door Panel (D) by Lifting the Panel up and into the Header (A). Lower the Panel and engage the Rollers (I) with the roller track.

Slide outside Door Panel into Wall Jamb located on wall opposite of shower head.

Check Panel to make sure that it is parallel to the Wall Jamb. If it is not, remove the Door Panel and adjust the rollers either up or down by loosening the Roller Screws and sliding the Rollers.

When satisfied with outside Door Panel alignment, proceed with inside Door Panel installation.

When installed, slide the inside Door Panel into the Wall Jamb located on **shower head wall** and check for alignment with Wall Jamb. Adjust Rollers as necessary.

STEP 7 Screw on Track Guide

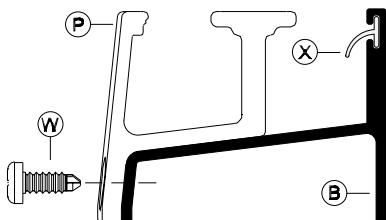

To insure proper operation, Track Guide (P) must be centered on Sill (B) when installed.

Open the shower door enclosure so that both Door Panels are up against the same Wall Jamb.

Locate the center of Sill and position the Track Guide on the Sill, making sure that the Door Panels are riding in their respective tracks.

Using the holes on Track Guide as templates, secure Guide to the Sill using two 638phpt Self Drilling Screws (W) as shown in figure above.

When finished, closed Door Panels as before (inside panel toward shower head wall, outside panel against opposite wall).

STEP 8 Towel Bar Installation

Close Door Panels (inside Panel against shower head wall and outside Panel against opposite wall). See figures 7A and 7B.

Note that both inner Brackets must be installed first. Do so at this time and secure to Panels with a #832 x 3/4" Towel Bar Screw (F).

Now finish Towel Bar installation for each Door Panel as shown in exploded view and secure with a #832 x 1-1/4" Towel Bar Screw (K). Don't forget the Finger Pulls (E).

Finish Towel Bar installation by peeling the back off the metallic Cl logo (V) and installing it over the screw head on the Finger Pulls (E) as shown in exploded view - front sheet.

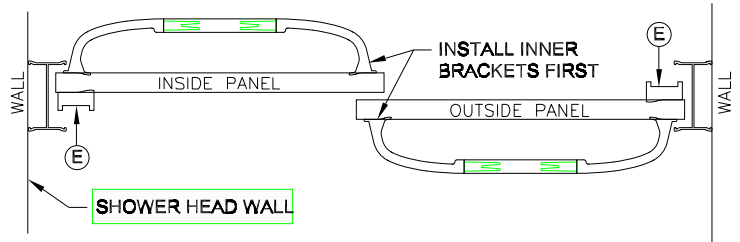

FIGURE 7A
(SHOWER HEAD ON LEFT)

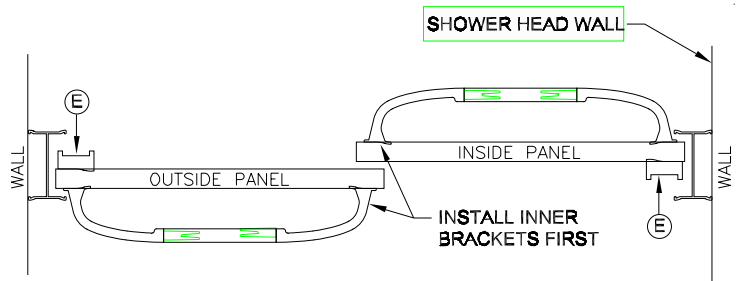

FIGURE 7B
(SHOWER HEAD ON RIGHT)

STEP 9 Leak Proof Installation

To insure a leak proof installation . . . Run a bead of clear mildew resistant caulking down the full length of each Wall Jamb **outside** where the Wall Jambs meet the walls. Now caulk the crevice where the sill meets either Wall Jamb. Follow caulking manufacturer's instructions before using shower. Installation is now complete.

