

Paragon Door

Installation Instructions

Explode View (standing outside of enclosure looking in) (left hand hinge shown)

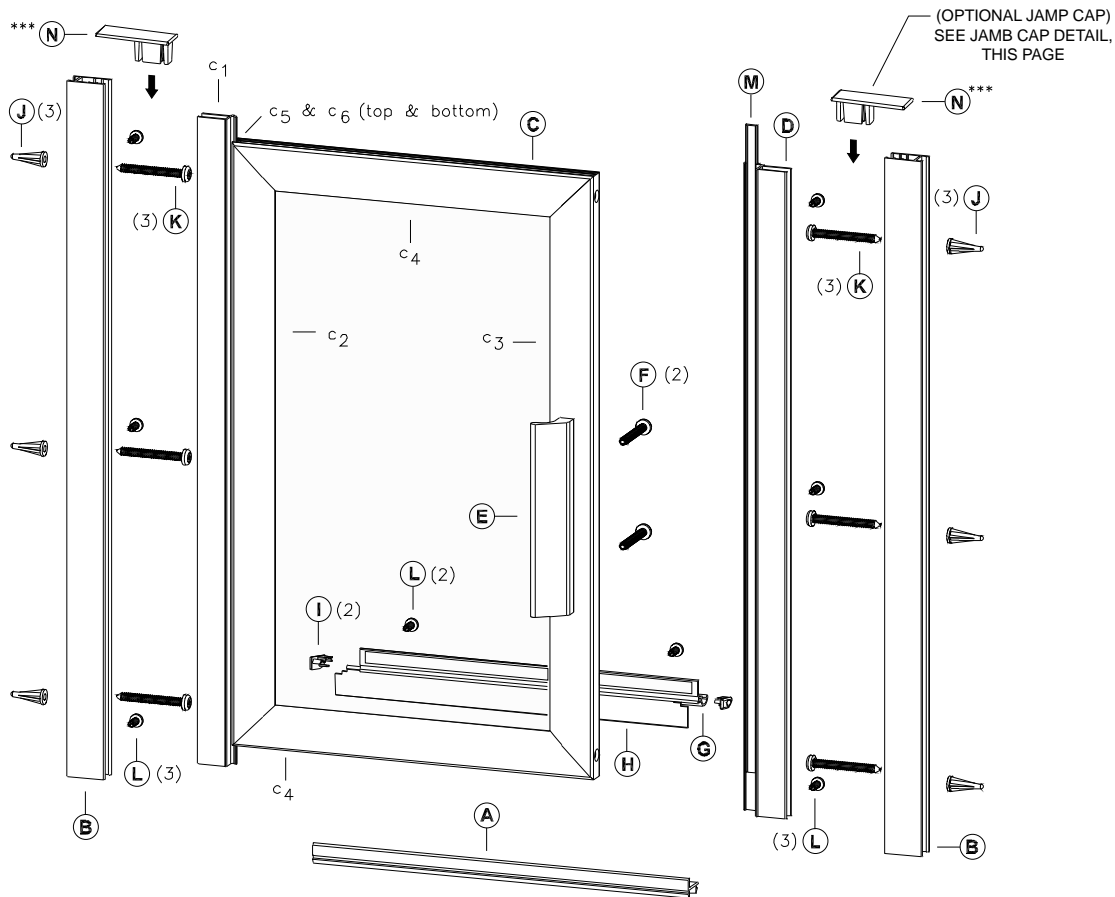

KEY LETTER	PART NUMBER	DESCRIPTION	QUANTITY
A	901	SILL	1
B	903	WALL JAMB	2
C	----	DOOR ASSEMBLY	1
c1	920	Hinge Post	1
c2	922	Hinge Stile	1
c3	924	Strike stile	1
c4	925	Rail	2
c5	CP932	Hinge Pins (not shown)	2
c6	CP148TW	Hinge Washer (not shown)	2
c7	C921B	Hinge Sleeve (not shown)	1
c8	C940B	Glazing Vinyl (not shown)	---
c9	98-42	Magnetic Strip (not shown)	1
c10	7-8114FHQ	Door Panel Assembly Screws	4

KEY LETTER	PART NUMBER	DESCRIPTION	QUANTITY
D	926	STRIKE POST	1
E	930	DOOR HANDLE (SET)	1
F	6114MSFHP	DOOR HANDLE SCREWS	2
G	927	DRIP RAIL	1
H	C176B	VINYL DOOR SWEEP	1
I	CP933	DRIP RAIL PLUG SET	1
J	1329	PLASTIC SCREW ANCHOR	6
K	6-8114PHP	INSTALLATION SCREWS	6
L	638PHPT	ADJUSTMENT SCREWS	8
M	98-42	MAGNETIC STRIP	1
*** N	CP903	JAMB CAP	2

*** Jamb Caps are optional and are ordered separately.

TURN JAMB CAP OVER AND SET IT ATOP THE WALL JAMB AND THE STRIKE JAMB AS SHOWN.

MAKE A TRIM MARK HERE ON JAMB CAP

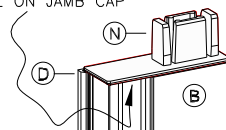

TRIM EXCESS OFF AND INSERT INTO CAVITY AS SHOWN

REPEAT STEPS FOR HINGE SIDE

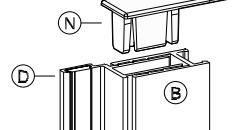

Jamb Cap Detail

1. Measure the base opening along center of shower curb as shown, then trim Sill (A) to 1/16" less than measurement obtained.

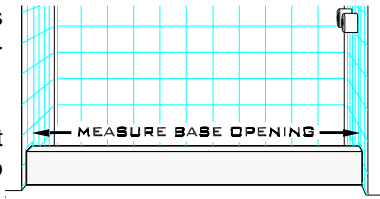

figure 1

2. With high lip toward exterior of enclosure, position Sill at center of shower curb. Temporarily tape Sill to shower curb to prevent movement.

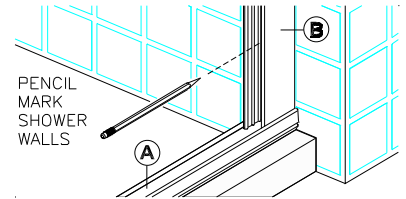

figure 2

Note: For **Door Only** Installations; Trim Wall Jambs (B) to the same height as the Strike Post (D) before proceeding; otherwise leave Wall Jambs as they are (no trimming) and continue the installation

3. Place Wall Jambs (B) on to ends of Sill (A) and up against shower walls as shown in figure 2. Plumb the Jambs, then pencil mark their installation holes locations on the shower walls (3 per jamb). Remove Wall Jambs. Using a 3/16" drill bit (designed to drill through material you are working with), drill 1" deep installation holes in locations previously marked. Insert Plastic Screw Anchors (J) into holes.

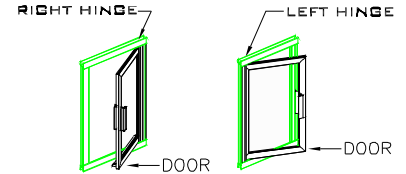

figure 3

4. Reposition Wall Jambs (B) as before and secure Jambs to walls using the six(6) 1-1/4" Installation Screws (K) provided (3 per jamb).

5. Decide from which side your Door Assembly (D) is to hinge (left or right, your choice) see figure 3. Insert the Door Assembly's Hinge Post (c1) into the Wall Jamb from which it is to hinge. Now, insert the Strike Post (D) into the other Wall Jamb (see exploded view - sheet 1). Magnet on door should face toward interior of enclosure, while magnet on Strike Post should face toward the exterior.

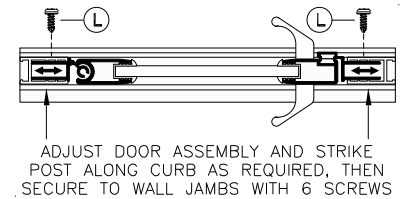

figure 4

6. Attach the Door Handles (E) to the Door Assembly using two(2) Door Handle Screws (F) as shown in exploded view - sheet 1.

7. Adjust Door Assembly and Strike Post along curb as required (see figure 4). Bottom of Door Assembly must always remain parallel to Sill in order for door to operate properly (see figure 5). When satisfied with door operation, secure Hinge Post (c1) and Strike Post (D) to the Wall Jambs (B) using six 638PHPT Screws (L), (see figure 4) and exploded view - sheet 1.

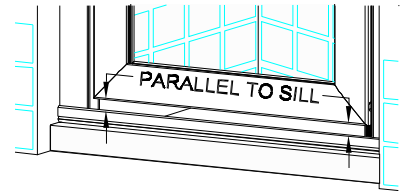

figure 5

8.*Notch and extend Vinyl Sweep (H) pass Drip Rail edge as shown in figure 6. Attach Drip Plugs (I) onto Drip Rail (see exploded view - sheet 1), be sure to remove the knockout on the hinge side drip plug so the water will drain (see figure 7). Clean bottom rail of door with alcohol to remove any oil. Failure to clean door rail prior to installation of Drip Rail (G) may cause tape to release. Remove backing from tape and position Drip Rail flush with backside of Hinge Stile (c2) as shown in figure 6. Sweep should cover gap at bottom of Door as shown in figure 8. Slightly elevate Drip Rail at strike side prior to securing to create a sloping effect.

Glass Note:

Two (2) optional self drilling screws (L) are provided in case you want to further secure the drip rail. If using screws to attach drip rail . . . **never** drill holes within 5/8" of exposed glass! To do so will result in glass breakage.

9. (Skip this step if Jamb Caps were not purchased). After all adjustments have been made, install a Jamb Cap (N) at both the hinge side and the strike side of the door as shown in exploded view - sheet 1. Trim Caps to required lengths before installing as shown in 'Jamb Cap Detail' on sheet 1.

10. Run a bead of clear mildew resistant caulking down the full length of each Wall Jamb **outside** where the Jambs meet the Walls. Now run a bead **outside** where the Sill meets the curb. Follow caulking manufacturer's instructions before using shower (normally 24 hours). Installation is now complete.

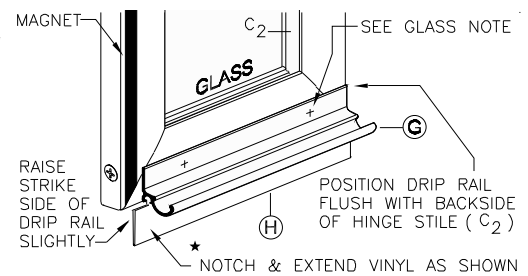

figure 6

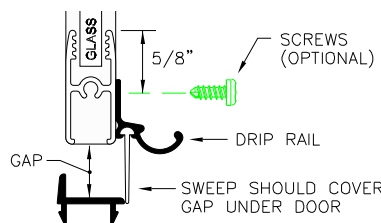

figure 8

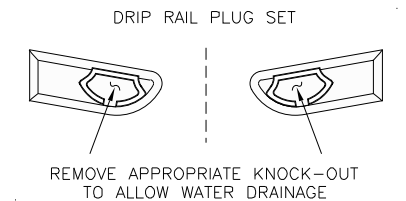

figure 7